

LED Panel Lights

40W 295x1195mm

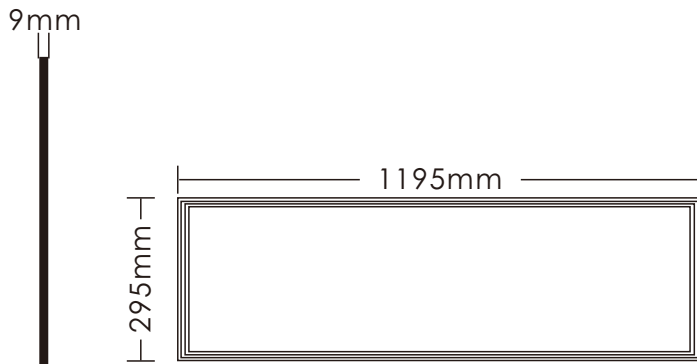

DIMENSIONS



LIGHT DISTRIBUTION CURVE

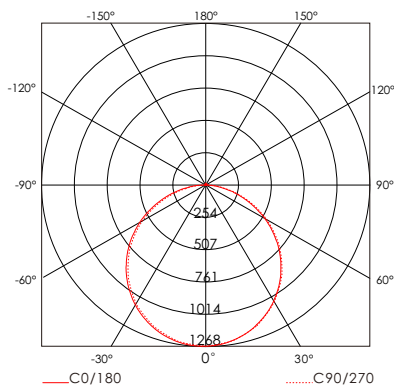

KEY DATA

Power	40W
Luminous Flux	4000lm
Colour Temperature	3000K/4000K/6500K
IP Rating	IP 20
Dimensions	295x1195x9mm
Warranty	3/5 Years Extended

Part Number 3000K

CL-PL-100-H30120-40W-WW

Part Number 4000K

CL-PL-100-H30120-40W-NW

Part Number 6500K

CL-PL-100-H30120-40W-CW

TECHNICAL SPECIFICATIONS

Input Voltage	200~240Vac
Power Factor	>0.9
Warm white(2700-3000K)	3600lm
Natural white(4000-4500K)	3800lm
Cold white(5800-6500K)	4000lm
LED Type	SMD4014/2835
LED brand	SANAN/EPSTAR
Luminous Efficacy	100lm/W
Driver Output Voltage DC	36-42V DC
Total Circuit Power(W)	40W+/-5%
Electrical Class	II
Colour Rendering	>80 CRI
Lamp Viewing Angle	120°
Dimmable(option)	Dali/0-10V/PWM/Traic
Operating Temp.	-20°C to +50°C
Lifespan	50,000 Hours
Flickering free(option)	Available
Light Guide Plate	Polystyrene
Housing Material	Aluminium
UGR<19(option)	Available
Weight	4.2Kg

Application



Office



School



Shopping mall



Hospital



Library



Conference room