

LED Wall pack 90W



KEY DATA

Power	90W
Luminous Flux	10800lm
Colour Temperature	3000K/4000K/6500K
IP Rating	IP 65
Dimensions	465x235x230mm
Warranty	5 Years Extended

Part Number 3000K

CL-WP-120-90W-01-WW

Part Number 4000K

CL-WP-120-90W-01-NW

Part Number 6500K

CL-WP-120-90W-01-CW

TECHNICAL SPECIFICATIONS

Input Voltage	90~264V AC
Power Factor	>0.90
Warm white(2700-3000K)	9300lm
Natural white(4000-4500K)	10260lm
Cold white(5800-6500K)	10800lm
LED Manufacturer	NICHIA
LED Type	SMD 3030
Luminous Efficacy	120lm/W
Driver Manufacturer	Meanwell
Total Circuit Power(W)	90W+/-5%
Electrical Class	II
Colour Rendering	>80 CRI
Lamp Viewing Angle	120°
Dimmable(option)	Dali/0-10V
Control option	Photocell/Motion sensor
Operating Temp.	-30°C to +50°C
Lifespan	55,000 Hours
Diffuser Material	Borosilicate glass
Housing Material	Aluminium
Mounting	Wall Mount
Weight	7.8Kg

DIMENSIONS

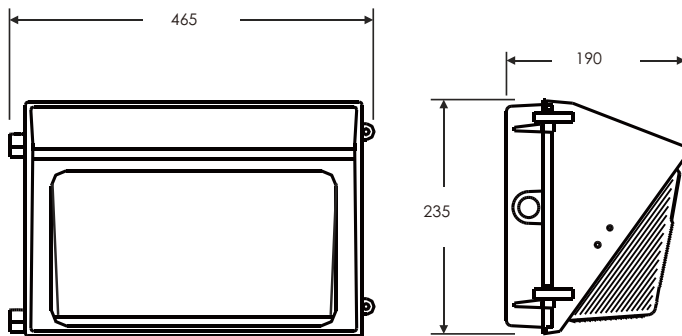

LIGHT DISTRIBUTION CURVE

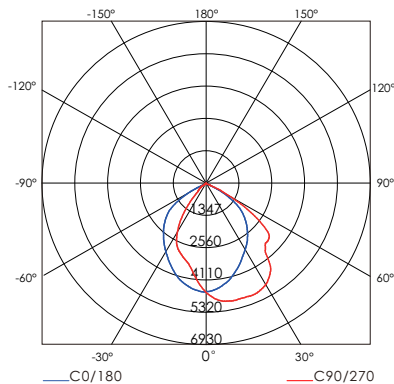

Application



Square, Plaza



Hospital



Warehouse



Logistic center



Architecture



Stadium